

IPA INFORMATION

ANGLE BRACKET HINGES

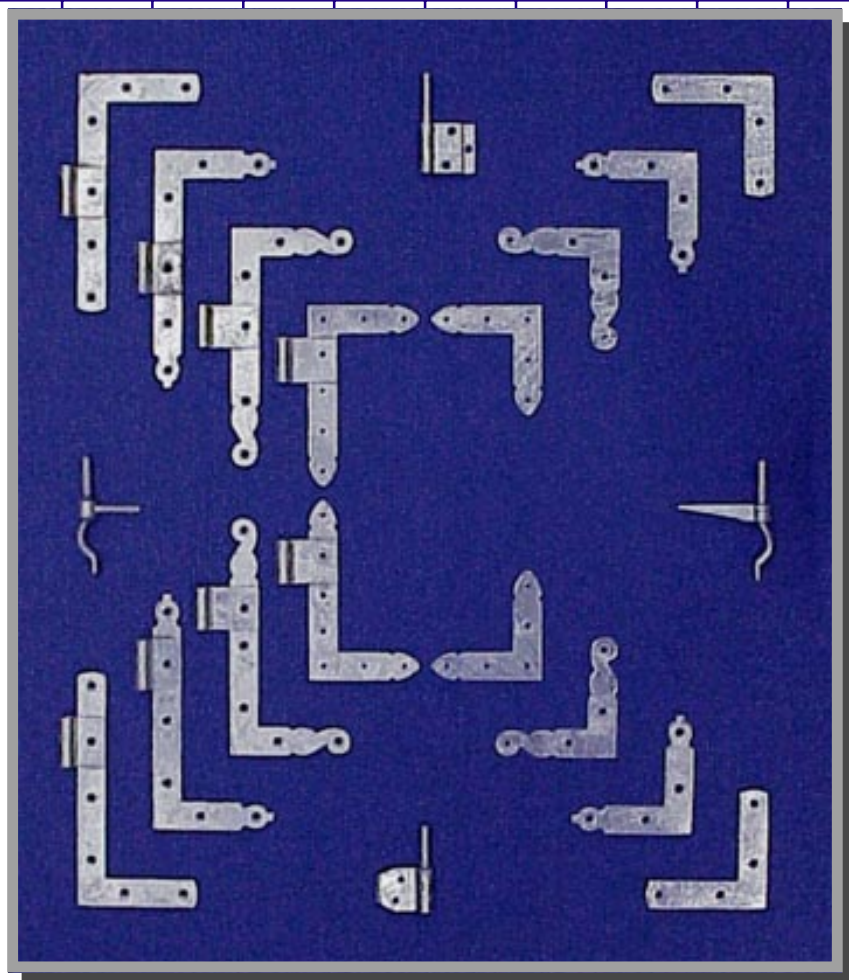

A/S J. PETERSENS BESLAGFABRIK

JACOB PETERSENSVEJ 9, DK-9240 NIBE

PHONE: (+45) 98 35 15 00



IPA's Selection of Angle Bracket Hinges for building new houses which can be in the same design as old houses or enabling old houses and barns to be renovated with their original look.

All IPA's Angle Bracket Hinges are delivered in a standard finish of Hot Dip Galvanized, but can by special order be delivered in any chosen colour.

ANGLE BRACKET HINGES

IPA STOCK NO.		LEFT/RIGHT	A MM	B MM	C MM	D MM	E MM	MATERIAL MM	PINTLES MM	SCREW/SCREW HOLE	NO.S IN EACH BOX
21513	17871	L	110	110	51	38	26	2,5	8	4,0	25 Pcs.
	18871	R									
21515	17871	L	175	110	77	38	26	2,5	8	4,0	25 Pcs.
	18871	R									
21516	17871	L	175	110	42,5	38	26	2,5	8	4,0	25 Pcs.
	18871	R									
21517	17871	L	215	110	119	38	26	2,5	8	4,0	25 Pcs.
	18871	R									
21518	17871	L	215	110	70,5	38	26	2,5	8	4,0	25 Pcs.
	18871	R									
21521	17871	L	175	110	98	38	26	2,5	8	4,0	25 Pcs.
	18871	R									
21522	17871	L	175	110	63,5	38	26	2,5	8	4,0	25 Pcs.
	18871	R									
21523	17871	L	215	110	138	38	26	2,5	8	4,0	25 Pcs.
	18871	R									
21524	17871	L	215	110	88,5	38	26	2,5	8	4,0	25 Pcs.
	18871	R									
21525	17871	L	175	110	98	38	26	2,5	8	4,0	25 Pcs.
	18871	R									
21526	17871	L	175	110	63,5	38	26	2,5	8	4,0	25 Pcs.
	18871	R									
21527	17871	L	215	110	138	38	26	2,5	8	4,0	25 Pcs.
	18871	R									
21528	17871	L	215	110	88,5	38	26	2,5	8	4,0	25 Pcs.
	18871	R									
21552	17871	L	175	110	65	22	26	2,5	8	4,0	5 Sets
	18871	R									
21553	17871	L	175	110	65	22	26	2,5	8	4,0	5 Sets
	18871	R									
21554	17871	L	175	110	44	22	26	2,5	8	4,0	5 Sets
	18871	R									
21562	17871	L	215	110	85	22	26	2,5	8	4,0	5 Sets
	18871	R									
21563	17871	L	215	110	85	22	26	2,5	8	4,0	5 Sets
	18871	R									
21564	17871	L	215	110	67	22	26	2,5	8	4,0	5 Sets
	18871	R									
21921	17871	L	165	100	88,5	36	26	2,5	8	5,0	5 Sets
	18871	R									
21922	17871	L	165	100	30	36	26	2,5	8	5,0	5 Sets
	18871	R									

IPA NO.s 21552 + 54 + 62 + 64 ARE IPA SYSTEM FITTINGS

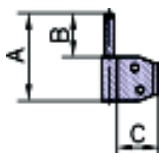
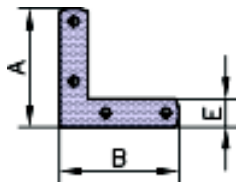
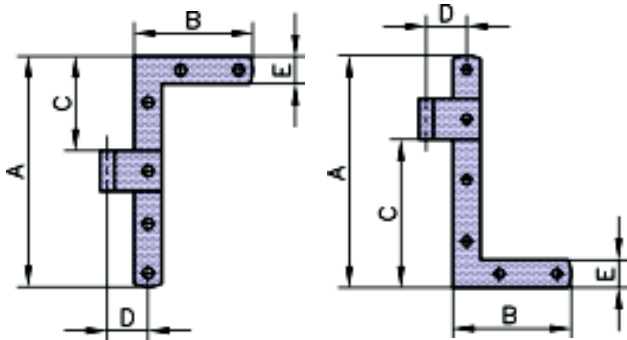

IPA No. 21531

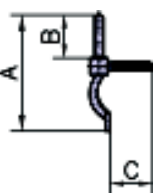
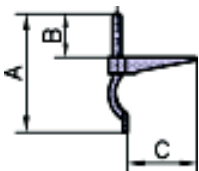

IPA No. 21533

IPA No. 21535

ANGLE BRACKETS

IPA STOCK NO.	A MM	B MM	C MM	MATERIAL MM	SCREW/SCREW HOLE	NO.S IN EACH BOX
21623	10871	110	110	26	2,5 4,0	50 Pcs.
21624	10871	110	110	26	2,5 4,0	50 Pcs.
21625	10871	110	110	26	2,5 4,0	50 Pcs.
21925	10871	100	100	26	2,5 5,0	50 Pcs.

PINTLES

IPA STOCK NO.	A MM	B MM	C MM	MATERIAL MM	PIN MM	HOLE	NO.S IN EACH BOX
21531	10871	80	40	38	3 8	6,0	25 Pcs.
21533	10871	110	40	65	3 8	4,5	25 Pcs.
21535	10871	110	40	38	8	4,5	25 Pcs.

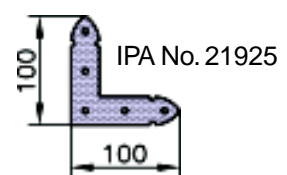
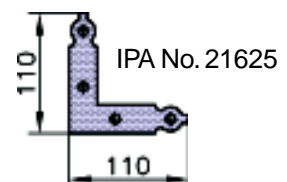
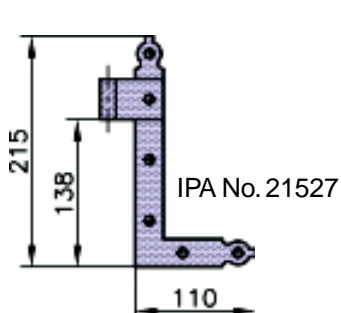
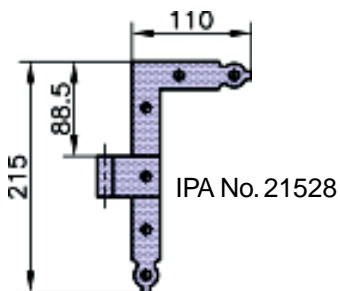
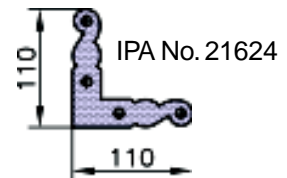
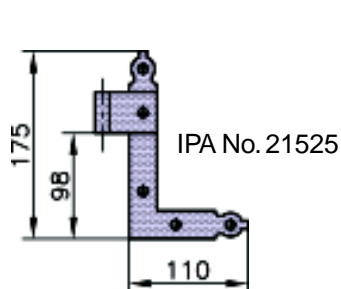
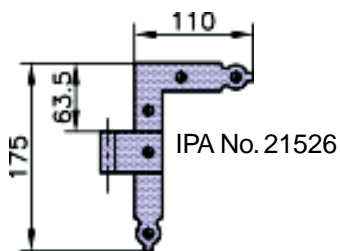
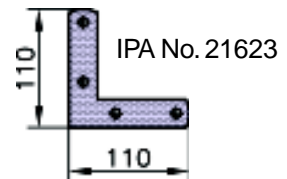
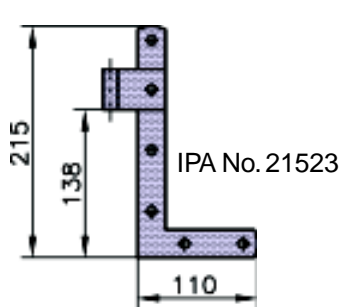
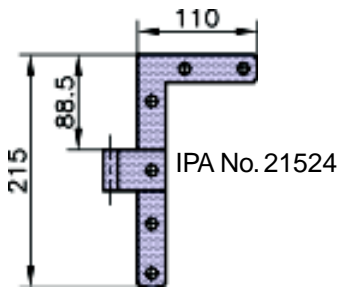
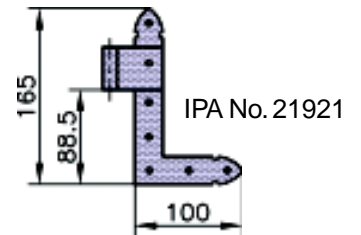
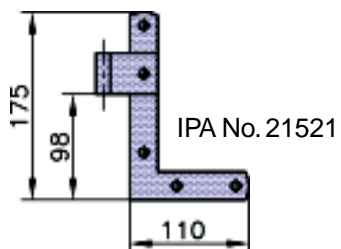
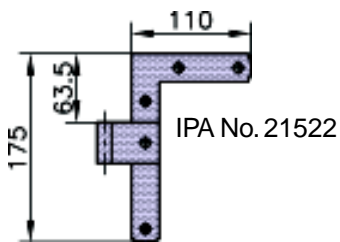
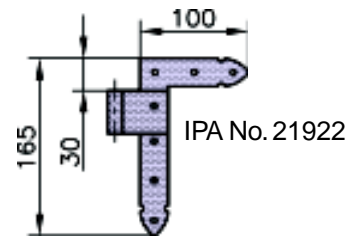
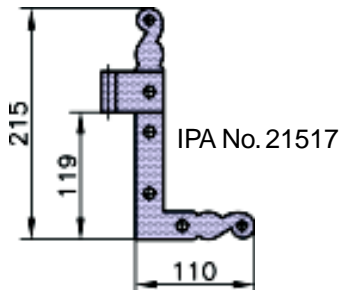
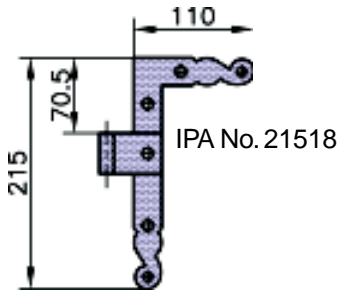
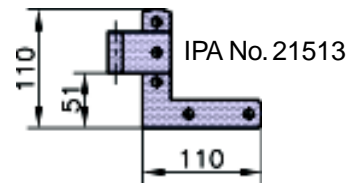
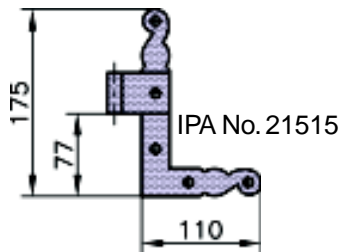
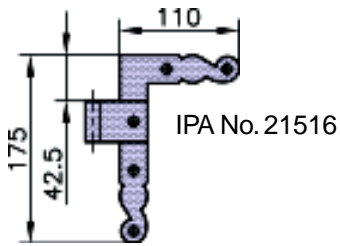

**THE ABOVE ANGLE BRACKET HINGES CAN BE USED TOGETHER WITH
IPA PINTLES NO.s 21531, 21533 AND 21535**

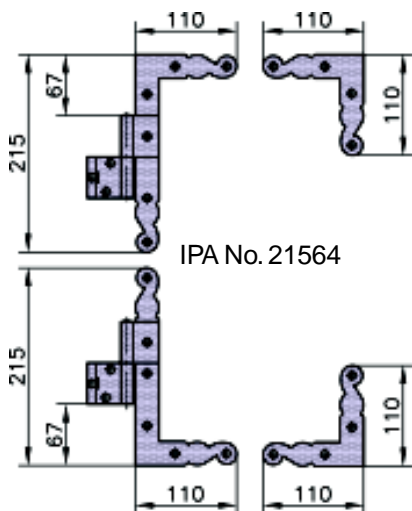

IPA No. 21564

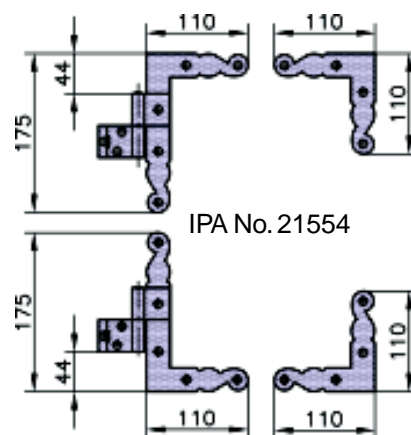

IPA No. 21554

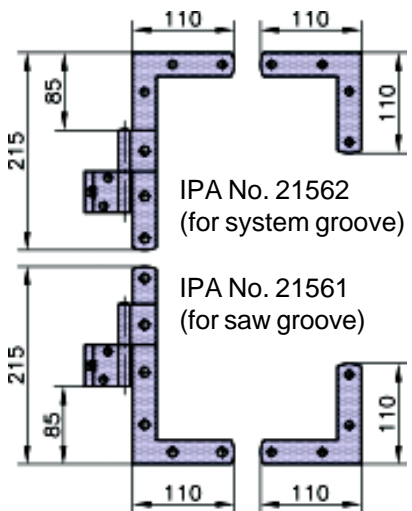

IPA No. 21562
(for system groove)

IPA No. 21561
(for saw groove)

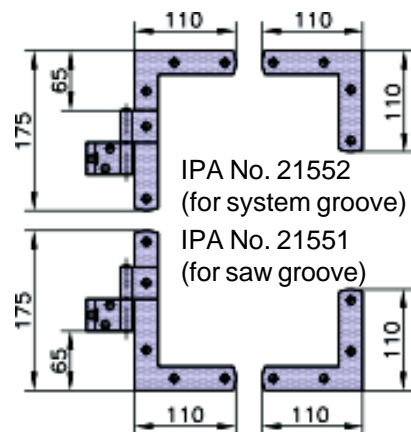

IPA No. 21552
(for system groove)

IPA No. 21551
(for saw groove)

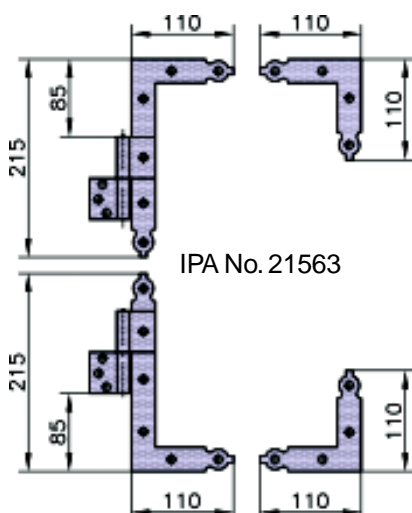

IPA No. 21563

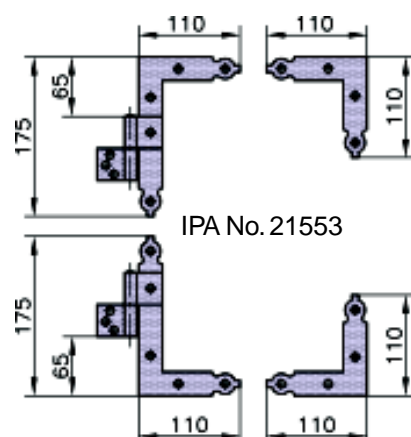

IPA No. 21553

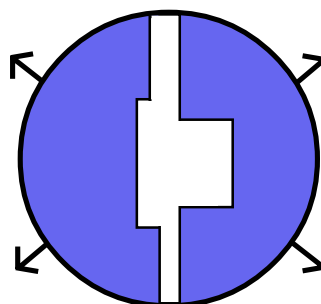

IPA SYSTEM GROOVE

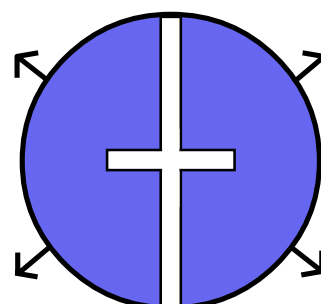

SAW GROOVE

**For further information, please contact
A/S J. Petersens Beslagfabrik (Phone +45 98 35 15 00)**